

# Electronic Timer - Series Micon® 225

## Signal Based Multi - Function

- Multi-function with Signal Start and Supply Start.
- 16 Timing Functions selected by DIP switch.
- Two independent relay outputs with either both relays timed or one timed and one instantaneous.
- Wide Input Signal & Supply range - 24-240V AC/DC.
- Wide Timing Range - 0.1 s to 120 days.
- High timing Accuracy.
- LED indicators for Power Supply & Relay Status.
- 22.5mm DIN Mount Housing.



### Cat. No.

**2A8DT6**

#### Parameters

Timer Description	<b>Multi-function with Signal Start and Supply Start</b>	
Supply Voltage (φ)	24-240 VAC / DC	
Supply Variation	- 20% to +10% (of φ)	
Frequency	50/60 Hz	
Power Consumption (Max.)	3 VA	
Initiate Time	100 ms (Max.)	
Reset Time	200 ms (Max.)	
Signal Voltage	Low Range (B1L-A2)	24-60V AC/DC
	High Range (B1H-A2)	85-265V AC, 100-265V DC
Signal Sensing Time	For AC Signals: 50 ms Max. For DC Signals: 20 ms Max.	
Signal stabilization Delay	100 ms (Applicable at Power ON Only)	
Setting Accuracy	± 5% of Full scale	
Repeat Accuracy	± 1%	
Output	Relay Output	1 C/O (Delayed) & 1 C/O (Configurable as either Delayed or Instant)
	Contact Rating	5A @ 240 VAC / 28 VDC (Resistive)
	Contact Material	AgNi
	Electrical Life	1x10 <sup>5</sup>
	Mechanical Life	1x10 <sup>7</sup>
Set Time (Ts)	0.1 seconds to 120 Days	
Functions	Refer page no. 23 and 24	
LED Indication on front panel	Green LED ON: Power ON, Amber LED ON :Relay ON for Delayed contact	
Mounting	Base / DIN Rail	
Max. Operating Altitude	2000 m	
Housing	Flame retardant (UL 94-V0)	
Operating Temperature	-10°C to +60°C	
Storage Temperature	-20°C to +70°C	
Humidity (Non Condensing)	95% (Rh)	
LED Indication	Green LED → Power ON, Red LED → Relay ON	
Enclosure	Flame Retardant UL94-V0	
Dimension (W x H x D) (in mm)	22.5 X 75 X 100.5	
Weight (unpacked)	130 g	
Pollution Degree	II	
Certification		
Degree of Protection	IP 20 for Terminals, IP 40 for Enclosure	
<b>EMI / EMC</b>		
Harmonic Current Emissions	IEC 61000-3-2	Ed. 3.2 (2009-04) Class A
ESD	IEC 61000-4-2	Ed. 2.0 (2008-12) Level II
Radiated Susceptibility	IEC 61000-4-3	Ed. 3.2 (2010-04) Level III
Electrical Fast Transients	IEC 61000-4-4	Ed. 3.0 (2012-04) Level IV
Surges	IEC 61000-4-5	Ed. 2.0 (2005-11) Level IV
Conducted Susceptibility	IEC 61000-4-6	Ed. 3.0 (2008-10) Level III
Voltage Dips & Interruptions (AC)	IEC 61000-4-11	Ed. 2.0 (2004-03) All 7 Levels
Conducted Emission	CISPR 14-1	Ed. 5.2 (20011-11) Class B
Radiated Emission	CISPR 14-1	Ed. 5.2 (20011-11) Class A
<b>Safety:</b>		
Test Voltage between I/P and O/P	IEC 60947-5-1	Ed.3.0 (2003-11) 2 kv
Test Voltage between all terminals & enclosure	IEC 60947-5-1	Ed.3.0 (2003-11) 4 kv
Impulse Voltage between I/P and O/P	IEC 60947-5-1	Ed.3.0 (2003-11) Level IV
Single Fault	IEC 61010-1	Ed.3.0 (2010-06)
Insulation Resistance	UL 508	Ed.17 (1999-01) > 50 M
Leakage Current	UL 508	Ed.17 (1999-01) < 3.5 mA
Product Reference Standard	IEC 61812-1	Ed.2.0 (2011-05)
<b>Environmental</b>		
Cold Heat	IEC 60068-2-1	Ed. 6.0 (2007-03)
Dry Heat	IEC 60068-2-2	Ed. 5.0 (2007-07)
Vibration	IEC 60068-2-6	Ed. 7.0 (2007-12) 5g
Repetitive Shock	IEC 60068-2-27	Ed. 4.0 (2008-02) 40g, 6ms
Non-Repetitive Shock	IEC 60068-2-27	Ed. 4.0 (2008-02) 30g, 15ms

### ORDERING INFORMATION

Cat. No.	Description
2A8DT6	24-240 VAC / DC, Signal Based Multi - Function, 1 C/O + 1 C/O

# Electronic Timer - Series Micon® 225

## Signal Based Multi - Function



### FUNCTIONAL DIAGRAMS

⏻: Supply Voltage, S: Input Signal, R: Relay Output, R(I): Instant Relay, R(D): Delayed Relay  
 T: Preset Time, TON: Preset ON Time, TOFF: Preset OFF Time, T-a: Timing Break Before completion

#### ON DELAY (Non Signal Based)

When supply is applied, timing starts and after the preset time duration 'T', output switches ON and remains ON till the supply is present.

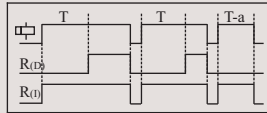

#### CYCLIC ON/OFF

When the supply applied and signal is closed, output switches ON for the preset time duration 'T' and then switches OFF for preset time duration 'T'. This cycle repeats while the supply is present. Changing the state of signal during 'T' does not affect the output.

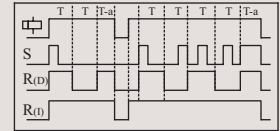

#### SIGNAL ON DELAY TYPE 1

When the input supply & signal are applied, timing starts and after preset time duration 'T' output switches ON & remains ON till the supply is present. Changing the state of signal during 'T' does not affect the output.

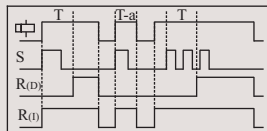

#### SIGNAL ON/ OFF Delay

Signal ON/OFF Delay: When the supply is applied and signal is closed, outputs switches ON after preset time 'T'. During the timing 'T' if signal is opened, the output switches ON immediately and OFF delay starts. Once this time period has elapsed the output switches OFF. During this OFF delay if signal is closed, the output switches OFF immediately and ON Delay restarts.

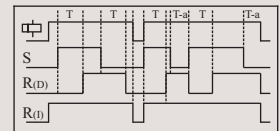

#### SIGNAL ON DELAY

Time commences as supply and signal are present. When input signal is opened, the timing resets. The output is switched ON at the end of the preset time duration 'T'. When output is ON if signal is opened then the output switches OFF.

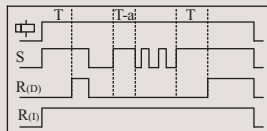

#### IMPULSE ON/OFF

When supply is applied and if signal closed or opened, output switches ON for Preset time duration 'T'. During time period 'T', changing state of input signal does not affect the output but resets the timing.

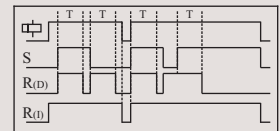

#### INVERTED SIGNAL ON DELAY

When supply is applied and signal is opened, preset time duration 'T' starts. On completion of the 'T', output switches ON. If the signal is closed during timing 'T', timing resets.

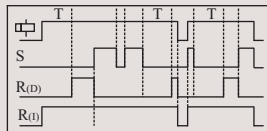

#### ACCUMULATIVE DELAY ON SIGNAL

Accumulative Delay ON Signal: On application of the supply voltage, the preset timing commences. Whenever signal is closed, timing pauses & resumes back only when the input signal is opened. The output switches ON at the end of the preset time duration 'T'.

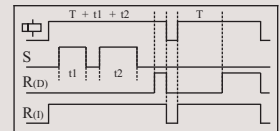

#### INTERVAL

When supply voltage is applied & signal is closed, output switches ON & timing function starts. If signal is opened and closed during the preset time, the timing restarts. After preset time 'T' has elapsed, the output switches OFF.

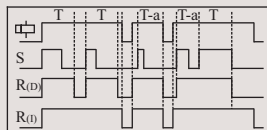

#### DELAYED IMPULSE

Delayed Impulse: When supply voltage is applied and signal is closed, output switches ON at the end of the preset time 'TOFF'. Then the preset ON time 'TON' starts irrespective of the signal state and remains ON till the completion of preset time duration 'TON'. If signal closed during the timing 'TOFF', the timing restarts but the output state remains unaffected. The signal change does not have any effect during the timing period 'TON'.

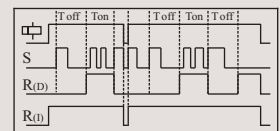

#### LEADING EDGE IMPULSE

When the supply applied and signal is closed, the output switches ON for preset time 'T'. After the completion of preset time 'T', the output switches OFF. If signal closed or opened during preset time duration 'T', the output remains unaffected.

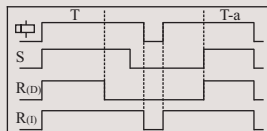

#### ONE SHOT

One Shot: When the supply voltage is applied and signal is closed, timing starts and after the preset time duration 'T', output switches ON for One sec. only.

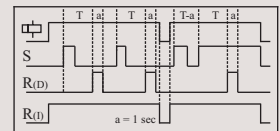

#### TRAILING EDGE IMPULSE

When supply voltage is applied and signal is opened, output switches ON for the preset time duration 'T'. After completion of preset time 'T', output switches OFF. If the signal is closed during preset timing 'T', output switches OFF & timing stops.

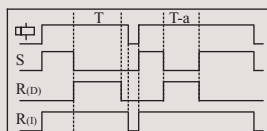

#### STEP MODE

Step Mode: When the supply voltage is applied and signal closed, output switches ON for preset time duration 'T', removal of the input signal during this time duration 'T' does not affect the output state. But if the signal is closed during time duration 'T', output switches OFF.

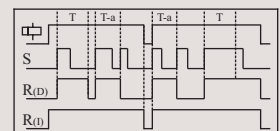

#### CYCLIC OFF/ON

When the supply applied and signal is closed, output switches OFF for the preset time duration 'T' and then switches ON for preset time duration 'T'. This cycle repeats while the supply is present. Changing the state of signal during 'T' does not affect the output.

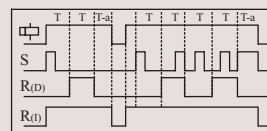

#### SIGNAL OFF DELAY

Signal OFF Delay: When the supply is applied and signal is closed, output switches ON. When signal is opened, the preset timing commences and output switches OFF at the end of time duration 'T'. If signal is closed during timing period, then timing stops and restarts when signal.

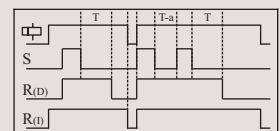

# Electronic Timer - Series Micon® 225 Signal Based Multi - Function



**Selection of Function:** Operating Mode & timing can be selected by using DIP switches

Function		Function	
1 2 3 4 ■ ■ ■ ■	On Delay (Non Signal)	1 2 3 4 ■ ■ ■ ■	Signal OFF Delay
■ ■ ■ ■	Signal On Delay Type 1	■ ■ ■ ■	Step Mode
■ ■ ■ ■	Signal On Delay	■ ■ ■ ■	One Shot
■ ■ ■ ■	Inverted Signal On Delay	■ ■ ■ ■	Delayed Impulse
■ ■ ■ ■	Interval	■ ■ ■ ■	Accumulative Delay On Signal
■ ■ ■ ■	Leading Edge Impulse	■ ■ ■ ■	Impulse ON / OFF
■ ■ ■ ■	Trailing Edge Impulse	■ ■ ■ ■	Signal ON / OFF Delay
■ ■ ■ ■	Cyclic OFF / ON	■ ■ ■ ■	Cyclic ON / OFF
1I + 1D or 2D Selection		Timing Multiplier Selection	
5 □	1I + 1D Operation	6 ■	Timing = 'T' X 't' X 1
■	2 Delayed Operation	■	Timing = 'T' X 't' X 12

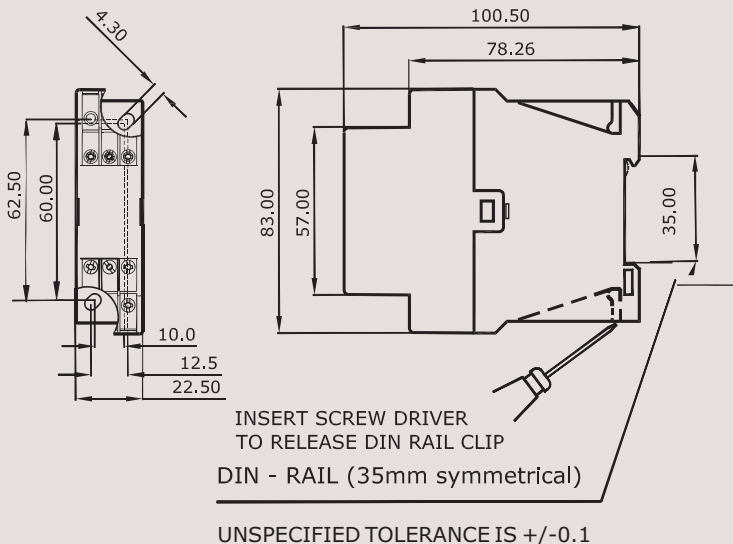

## MOUNTING DIMENSION (mm)

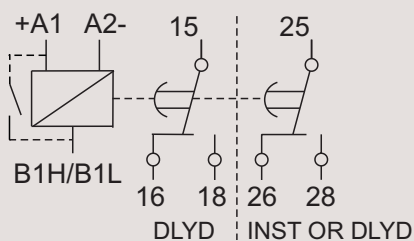

## CONNECTION DIAGRAM

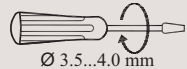

## TERMINAL TORQUE & TERMINAL CAPACITY

 Ø 3.5...4.0 mm	Torque - 0.6 N.m (6 Lb.in) Terminal screw - M3
	1 X 1...4 mm <sup>2</sup> Solid /Stranded Wire
AWG	1 X 16 to 12